

DRIVE EVO2

RACK ACTUATOR

OPENING STROKE SIZES

180, 230, 350, 550, 750 or 1000 mm

PUSH FORCE

1000 N

VOLTAGE

230V AC - 24V DC (+/- 10%)



DESCRIPTION

MINGARDI linear electric actuator with movement by a 12x12 section rack contained inside the aluminium tubular. Operating voltages: 110 - 240 V AC (50/60 Hz) or 24V DC in compliance with Directive 2006/42/EC and 2014/30/EC. 24V DC version tested in accordance with the requirements of the European Standard EN 12101 - 2: 2017. Outfitted with a system of electronic limit switch in opening and closing with overload protection. It can be connected in parallel. Gearmotor body in alluminum grey RAL 9006, galvanized steel rack. Complete with fixing accessories.

WINDOW TYPES

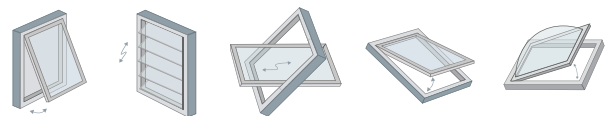

APPLICATION



COMFORT
VENTILATION



SMOKE
VENTILATION

COLOURS

- Silver Anodised
- ⊗ Custom RAL colour

CERTIFICATION

Certified and tested in accordance to EN 12101-2



TECHNICAL DATA

	230V AC	24V DC (+/- 10%)
Voltage	230V AC	24V DC (+/- 10%)
Push Force	1000 N	1000 N
Pull Force	1000 N	1000 N
Opening Stroke	180, 230, 350, 550, 750 or 1000 mm	180, 230, 350, 550, 750 or 1000 mm
Opening Speed	7 mm/s	7 mm/s
Current Consumption	0.15 A	1.41 A
Operating Conditions	-10°C - +40°C	-10°C - +40°C
Switch-on Duration	S2 4 min	S2 4 min
Colour	Silver Anodised or custom RAL colour	Silver Anodised or custom RAL colour
IP Rating	IP 25	IP 25
Life Span	10,000 opening and closing movements	10,000 opening and closing movements
Delivery Includes	1 x Actuator, 1 x Pivot Bracket & 1 x Vent Bracket	1 x Actuator, 1 x Pivot Bracket & 1 x Vent Bracket
Flex Length	1.5 m	1.5 m
Cable Dimensions	3-Core & Earth	2-Core
Min. window width	> 50 mm	> 50 mm
Max. window width	< 1300 mm (use multiple actuators if wider)	< 1300 mm (use multiple actuators if wider)
Synchronisation	No	No

ACCESSORIES

DRIVE-EVO2700064	- Vent Bracket
DRIVE-EVO2700518	- Pivot Bracket
DRIVE-EVOBAR1140	- Connecting Bar 1140 mm
DRIVE-EVOBAR1390	- Connecting Bar 1390 mm
DRIVE-EVOBAR1640	- Connecting Bar 1640 mm
DRIVE-EVOBAR1890	- Connecting Bar 1890 mm
DRIVE-EVOBAR890	- Connecting Bar 890 mm
DRIVE-EVOCOLLAR	- Fixing Pack for Connecting Bar
DRIVE-EVOSLAVE1000	- Slave Actuator 1000 mm
DRIVE-EVOSLAVE180	- Slave Actuator 180 mm
DRIVE-EVOSLAVE230	- Slave Actuator 230 mm
DRIVE-EVOSLAVE350	- Slave Actuator 350 mm
DRIVE-EVOSLAVE550	- Slave Actuator 550 mm
DRIVE-EVOSLAVE750	- Slave Actuator 750 mm

PART CODES

DRIVE-EVO230180	- DRIVE EVO2 Actuator 230 V 180 mm
DRIVE-EVO230230	- DRIVE EVO2 Actuator 230 V 230 mm
DRIVE-EVO230350	- DRIVE EVO2 Actuator 230 V 350 mm
DRIVE-EVO230550	- DRIVE EVO2 Actuator 230 V 550 mm
DRIVE-EVO230750	- DRIVE EVO2 Actuator 230 V 750 mm
DRIVE-EVO2301000	- DRIVE EVO2 Actuator 230 V 1000 mm
DRIVE-EVO24180	- DRIVE EVO2 Actuator 24 V 180 mm
DRIVE-EVO24230	- DRIVE EVO2 Actuator 24 V 230 mm
DRIVE-EVO24350	- DRIVE EVO2 Actuator 24 V 350 mm
DRIVE-EVO24550	- DRIVE EVO2 Actuator 24 V 550 mm
DRIVE-EVO24750	- DRIVE EVO2 Actuator 24 V 750 mm
DRIVE-EVO241000	- DRIVE EVO2 Actuator 24 V 1000 mm

DIMENSIONS

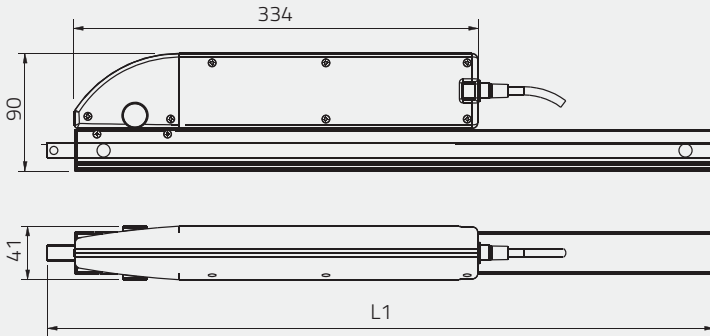

Stroke	180 mm	L1 = 340 mm
Stroke	230 mm	L1 = 390 mm
Stroke	350 mm	L1 = 510 mm
Stroke	550 mm	L1 = 710 mm
Stroke	750 mm	L1 = 910 mm
Stroke	1000 mm	L1 = 1160 mm

CONTROLS



SCU-4
AOV Control Unit



SCU-CP
Override Switch



PSU-2/4/8
24V DC Transformer



WSC 310
AOV Control Unit

